

TOTO

TOTO U.S.A., Inc.

1155 Southern Road Morrow, GA 30260

Phone : (770) 282-8686

Warranty Registration and Inquiry

For product warranty registration, TOTO U.S.A. Inc. recommends On-Line Warranty Registration. Please visit our web site <http://www.totousa.com>. If you have questions regarding warranty policy or coverage, please contact TOTO U.S.A. Inc.,

Customer Service Department, 1155 Southern Road, Morrow, GA 30260 (888) 295 - 8134 or (678) 466 - 1300 when calling from outside of U.S.A.

- You are advised to record the following information to allow quick service.

Date of purchase :	Name of shop :
Date : year month day	Tel : ()

WASHLET

washlet

SW3074T40
SW3074
SW3024

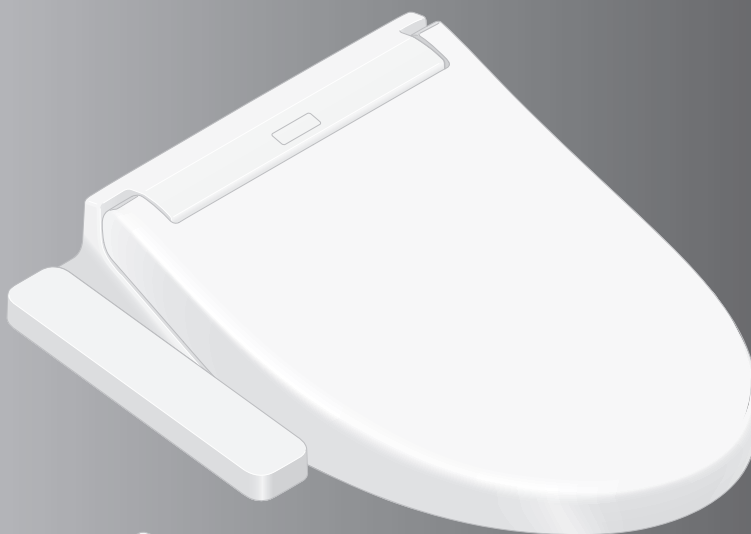

SW3073
SW3023



- Thank you for your recent purchase of this product.
Please read the enclosed information to ensure the safe use of your product.
- Be sure to read this Instruction Manual before using your product and keep it in a safe place for future reference.

What functions are available on your product?

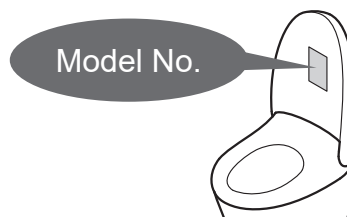

Functions			Model No.		Ref. Page
			SW3074T40 SW3074 SW3073	SW3024 SW3023	
Basic Functions	Washing	Rear washing	●	●	17
		Rear soft washing	●	-	
		Front washing	●	●	
	Changing the washing method	Wand position adjustment			
		Water pressure adjustment	●	●	
		Oscillating washing			
	Drying	Warm air drying	●	●	
Changing the temperature	Temperature adjustment	●	●	18, 19	
Sanitary Functions	Removing odors	Deodorizer	●	-	16
	"EWATER+" cleaning	Auto wand CLEAN	●	-	
	Bowl pre-cleaning	Pre-mist	●	-	
Convenience Functions	Heating the toilet seat	Heated seat	●	●	-
	Saving energy	Auto energy saver	●	●	20, 21
		Timer energy saver			
Maintenance		Main Unit One-touch removal			30, 31
		Removable toilet lid	●	●	32
		Wand cleaning			33

Keep It Clean

Sanitary Toilet



The self-cleaning functions operate automatically.
(See page 16 for details.)

	As you sit	As you stand up
Removing odors inside the bowl unit.	Deodorizer ^{*1}	Auto power deodorizer ^{*1}
A mist is automatically sprayed inside the bowl unit to make it more difficult for dirt to adhere.	Pre-mist ^{*2}	
Cleans the wand with "EWATER+"		Auto wand CLEAN ^{*3}

*1 Only used on models with "Deodorizer" function

*2 Only used on models with "Pre-mist" function

*3 Only used on models with "Auto wand CLEAN" function

Table of Contents

Safety Precautions	4	Introduction
Operational Precautions	11	
Parts Names	12	
Preparation	14	

Basic Operations	16	Operation
● Mechanism of Auto Functions (SW3074T40, SW3074, SW3073)	16	
Deodorizer, Auto wand CLEAN, Pre-mist		
● Using the Control Panel	17	
Temperature Adjustment (Toilet Seat, Warm Water, Drying)	18	
Energy Saver Features	20	
Various Operations	24	
● Setting List	24	
● Auto functions	26	

Maintenance	28	Maintenance
● Power Plug	28	
● Main Unit	29	
● Gap between the Main Unit and Bowl Unit	30	
● Gap between the Main Unit and the Toilet Lid	32	
● Deodorizing Filter	33	
● Wand	33	
Wand cleaning		
● Water Filter Drain Valve	34	

What to Do?	35	Reference
● If the water does not flow due to a water service interruption	35	
● Freeze Damage Prevention	36	
● Long Periods of Disuse	37	
Troubleshooting	38	
Specifications	42	
Limited Warranty	43	

Introduction

Operation



Maintenance

Reference



Safety Precautions



IMPORTANT SAFEGUARDS READ ALL INSTRUCTIONS BEFORE USING

Symbols and Meanings

	WARNING May result in death or serious injury.
	CAUTION May result in injury or property damage.

The following symbols are used to indicate important safety instructions for the use of the product.

Symbol	Meaning
	This symbol indicates a prohibited use of the product.
	This symbol is used to indicate a required step in the use of this product.

 WARNING	
	<p>Do not plug or unplug the power plug with wet hands.</p> <ul style="list-style-type: none"> • Doing so may cause electrical shock. <p>Do not get any water or cleaning solution on the main unit or power plug.</p> <ul style="list-style-type: none"> • Doing so may cause fire, electrical shock, heat or short circuit. • Doing so may cause the product to crack resulting in injury or water damage. <p>Never disassemble, repair or alter.</p> <p>Doing so may cause fire, electrical shock, overheating, short circuit or breakdown.</p> <p>Do not install the product on moving vehicles such as wheeled vehicles or boats.</p> <ul style="list-style-type: none"> • Doing so may cause fire, electric shock, short circuit or malfunction. • The toilet seat, toilet lid, main unit, or other parts may come loose and fall off, resulting in injury. <p>Do not use the product if a malfunction occurs.</p> <ul style="list-style-type: none"> • In case of breakdown or other problem, be sure to cut off power by means such as unplugging the power plug. Close the water shutoff valve to stop water supply. <p>Possible malfunctions:</p> <ul style="list-style-type: none"> - Water is leaking from a pipe or the main unit. - The product is cracked or broken. - The product makes a strange noise or emits a strange odor. - The product emits smoke. - The product is abnormally hot. - The toilet seat cushion is out of place. <ul style="list-style-type: none"> • Continued use after malfunction could cause a fire, electric shock, heat, short circuit, injury or water damage.

WARNING

Do not use other water than allowed by the laws and ordinances of the region of use. Only Use potable water.

Do not use seawater or recycled water.

- Doing so may cause irritation to the skin and malfunction.

Do not touch the power plug during thunderstorms.

- Doing so may cause electrical shock.

Do not allow the water supply hose to touch the power plug or outlet.

- Doing so may cause condensation resulting in a fire, electrical shock, heat or a short.

Do not do anything that may damage the power cord, power plug.

Do not strike, yank, twist, excessively bend, damage, alter, or heat the power cords.

Also, do not place anything heavy on, bind or pinch the power cords.

- Using a damaged power cord may result in a fire, electrical shock, heat or short.

Do not use a loose or faulty electrical outlet.

- Doing so may cause fire or short circuit.

Do not use any outlet or wiring equipment beyond its specified rating.

- Plugging too many plugs into the same outlet, for example using outlet splitters, can cause fire due to heat.

Do not use any power supply other than the one specified.

AC 120 V, 60 Hz

- Doing so may cause fire or excessive heat.

Do not stick a finger or anything else into the warm air outlet.

Do not place anything on the warm air outlet or drape clothes over it.

- Doing so may cause burns, electrical shock or malfunction.

Keep cigarettes and other open flames away from the product.

- Failure to do so may cause fire.

Refrain from sitting on the seat for long periods.

- It may cause low-temperature burns.

To prevent the following persons from getting a moderate temperature burn during use, other person should turn off the toilet seat heater.

- Young children, the aged and other users unable to set the temperature appropriately themselves.
- The ill, physically disabled and others who do not have freedom of movement.
- Those using any medicines that cause drowsiness (sleeping or cold medicine), those who have been drinking heavily, anyone severely fatigued and anyone else liable to fall asleep.



Safety Precautions (Continued)

WARNING

This is an electrical product. Do not install it anywhere water is likely to get on the product or anywhere with humidity high enough that water is likely to form on the surface of this product. When using the product in a bathroom, install a fan or ventilation port and ensure good air flow through the bathroom.

- Failure to do so may cause fire or electrical shock.

Always connect the product to the cold water supply.

- Connecting to hot water supply may result in burns and equipment damage.

Make sure that a properly grounded (3 prong) outlet has been installed.

- Failure to install a grounded outlet could cause electrical shock in the event of a malfunction or short circuit.

Insert the power plug securely into the outlet.

- Failure to do so may cause fire, heat or short circuit.

To unplug, hold the power plug, not the power cord.

Do not unplug by pulling the power cord.

- Pulling on the power cord may cause damage and result in fire or heat.

If the power cord is damaged, avoid danger by having the manufacturer's repair department or equivalent specialist replace it.

Always unplug the power plug from the outlet before maintenance or inspection.

- Failure to do so may cause electrical shock or malfunction.

Periodically remove dust and dirt from the power plug and make sure it is securely plugged into the wall outlet.

- Failure to do so may cause fire, heat or short circuit.

Pull the power plug out from the outlet and wipe clean with a dry cloth.

Always unplug the power plug from the outlet before removing the main unit.

- Failure to do so may cause fire or electrical shock.

Preliminary studies in females suggest that overuse of continuous spraying can increase the possibility of vaginal mucosa drying and potential reduction in desirable microbial organisms.

Although these studies have not been validated, please consult your healthcare provider for concerns regarding whether these circumstances may apply to you.

More importantly, if you are an individual suffering from any immune deficiency as a result of disease, chemotherapy, or other medical condition compromising the immune system you should consult your healthcare provider before use of this product.



CAUTION

Do not use the product if the main unit is unstable.

- Doing so may cause the main unit to come loose and fall, resulting in injury.

If the product is damaged, do not touch the damaged section.

- Doing so may cause electrical shock or injury.
Replace it immediately.

Do not apply strong force, mechanical shock, step on or stand on the toilet seat, toilet lid or main unit. Also do not place any heavy object on the toilet seat, toilet lid or main unit.

- Doing so may cause cracking or cause the main unit to come loose and fall, resulting in injury.
- Doing so may damage the product and cause injury or water damage.

Do not lift up this product by the toilet seat or lid.

Do not raise the toilet seat or lid while objects are resting on top of the unit.

- Doing so may cause the main unit to come loose and fall, resulting in injury.

When maintaining the plastic parts (main unit etc.) or the water supply hose, use a pH neutral kitchen detergent diluted with water. Do not use any of the following.

Toilet cleaner, household cleaner, benzene, paint thinner, powdered cleanser or nylon scrubbing brush.

- These items may damage or crack the plastic and cause injury or malfunction.
- These items could damage the water supply hose and cause a water leak.

To prevent a sudden water leak, do not remove the water filter drain valve when the shutoff valve is open.

- Doing so will cause water to spurt out.
(Refer to Page 34 for instructions on cleaning the water filter drain valve.)

Do not fold or crush the water supply hose; do not damage by cutting with a sharp object.

- Doing so may cause water leaks.

Do not install the base plate, which is not attached.

- Doing so may cause damage.



Safety Precautions (Continued)

CAUTION

If a water leak should occur, always close the shutoff valve.

When the ambient temperature is likely to drop to 32 °F (0 °C) or lower, prevent damage to the pipes and hoses due to freezing.

- Frozen water pipes could cause the main unit and the pipes to break, resulting in a water leak.
- Regulate the room temperature to prevent the pipes and hoses from freezing during cold months.
- Drain the water.

When not using the product over an extended period of time, drain the water out of the main unit and the water supply hose after closing the water shutoff valve, and pull the power plug from the outlet.

- When using the product again, allow the product to refill with water first. Otherwise, the water in the tank might become contaminated and cause skin inflammation or other problems. (Refer to Page 37 for instructions on replenishing the water.)
- Leaving the power on may cause fire or heat.

When installing the water filter drain valve, make sure that it is securely tightened in its proper position.

- Failure to securely tighten it may cause a water leak.

Push the main unit securely on to the base plate.

- After pushing the main unit until a click sound is heard, pull it slightly toward you to make sure that the product does not detach.
- Doing so may cause the main unit to come loose and fall, resulting in injury.



**DANGER** To reduce the risk of electrocution:

1. Do not use while bathing.
2. Do not place or store the product where it can fall or be pulled into a tub or sink.
3. Do not place in or drop into water or other liquid.
4. Do not reach for the product when it has fallen into water. Unplug it immediately.

**WARNING** To reduce the risk of burns, electrocution, fire or injury to persons:

1. Close supervision is necessary when this product is used by, on, or near children or invalids.
2. Use this product only for its intended use as described in this manual. Do not use attachments not recommended by the manufacturer.
3. Never operate this product if it has a damaged cord or plug, is not working properly, has been dropped or damaged, or has been dropped in water. Return the product to a service center for examination and repair.
4. Keep the cord away from heated surfaces.
5. Never block the air openings on the product or place it on a soft surface, such as a bed or couch, where the air openings may be blocked. Keep the air openings free of lint, hair, and other similar items.
6. Never use while sleepy or drowsy.
7. Never drop or insert any object into any opening or hose.
8. Do not use outdoors. Do not operate where aerosol (spray) products are being used or where oxygen is being administered.
9. Connect this product to a properly grounded outlet only.
See "Grounding Instructions" in Page 10.
10. The tank should be filled with water only.

- Servicing should be performed by an authorized service representative.
- This product is for household use.

Safety Precautions (Continued)

Grounding Instructions

This product should be grounded. In the event of an electrical short circuit, grounding reduces the risk of electric shock by providing an escape wire for the electrical current.

This product is equipped with a cord having a grounding wire with a grounding plug.

The plug must be plugged into an outlet that is properly installed and grounded.



DANGER - Improper use of the grounding plug can result in a risk of electric shock.

If repair or replacement of the cord or plug is necessary, do not connect the grounding wire to either flat-head terminal.

Check with a qualified electrician or serviceman if the grounding wire instructions are not completely understood, or if in doubt as to whether the product is properly grounded.

SAVE THESE INSTRUCTIONS

Operational Precautions

■ For prevention of malfunctions

<About the seat switch>

- When you sit on the toilet seat, the seat switch turns ON, enabling you to use various features. (A click sound is heard when the seat switch is ACTIVATED.)

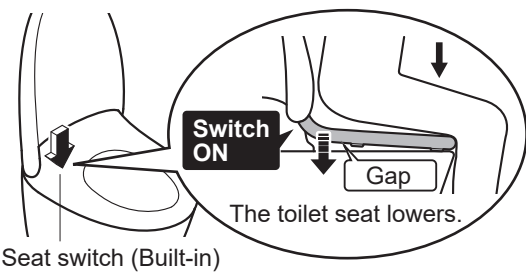

- Sit back on the toilet seat.
 - The seat switch will not turn on unless you sit on the seat properly.



Note

- When a child uses the product, the seat switch may not be ACTIVATED by their light body weight.
- Since the toilet seat is designed to move up and down, a clearance is provided between the toilet seat cushion and the bowl unit.

■ For prevention of damage

- Wipe plastic areas such as the main unit with a soft cloth tightly wrung out with water.

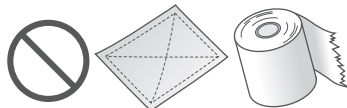

Dry cloth or tissue

- Do not lean against the toilet lid.



■ For prevention of malfunctions and failures

- Disconnect the power plug if there is a risk of lightning.
- A toilet seat cover or a toilet lid cover cannot be used. (The seat switch may not function properly. Additionally, the toilet seat and lid may not open or close properly.)
- Do not urinate on the main unit, toilet seat or wand. (Doing so may cause a failure or discoloration.)
- Do not apply strong forces to the control panel.
- When using a toilet cleaner to clean the toilet, rinse it off within 3 minutes and leave the toilet seat and toilet lid open. (If vapor from a toilet cleaner enters the main unit, it may cause a malfunction.)
 - Wipe off any cleaner that remains on the bowl unit.
- Do not use the product with the toilet lid removed.
- Do not expose to direct sunlight. (Doing so may cause changes in color, irregular heated seat temperature, the control panel malfunction or product malfunction due to the change in temperature.)
- Use radios, etc. away from the product. (The product could cause interference with the radio signal.)
- If you use a booster seat for infants or a soft highchair, remove it after use. (Keeping it installed may prevent some of the functions from being used.)
- Do not place anything on the toilet seat and lid, and do not press them with hands. (Failure to do so may turn on the seat switch, causing the floor to get wet if buttons on the control panel are touched and warm water comes out from the wand.)

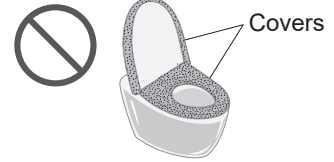

Parts Names

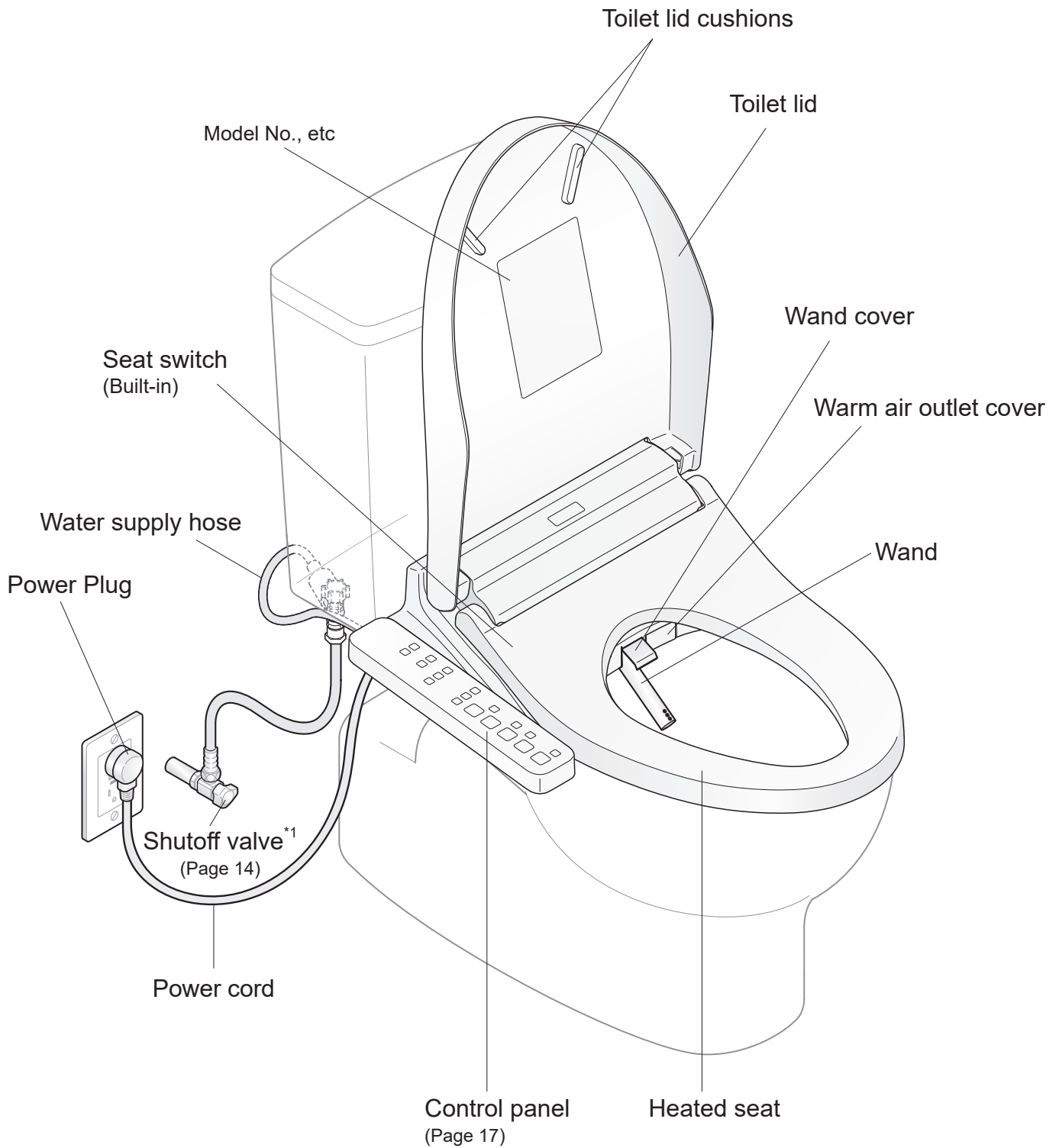

Descriptions in this manual are based on the illustrations of SW3074.
The toilet seat and the toilet lid shape vary by model.

*1 The shape and location vary depending on the type of toilet bowl and tank.

*2 Except SW3024, SW3023

Main display

Power LED	—	■	
Seat LED	—	■	
Energy saver LED	—	■	
Water LED	—	■	
Wand CLEAN LED ²	—	■	

<All the LEDs illuminate in the figure>

Right side of the main unit

Deodorizing filter² (Page 33)

Deodorizer outlet²

Main unit removal button (Pages 30, 31)

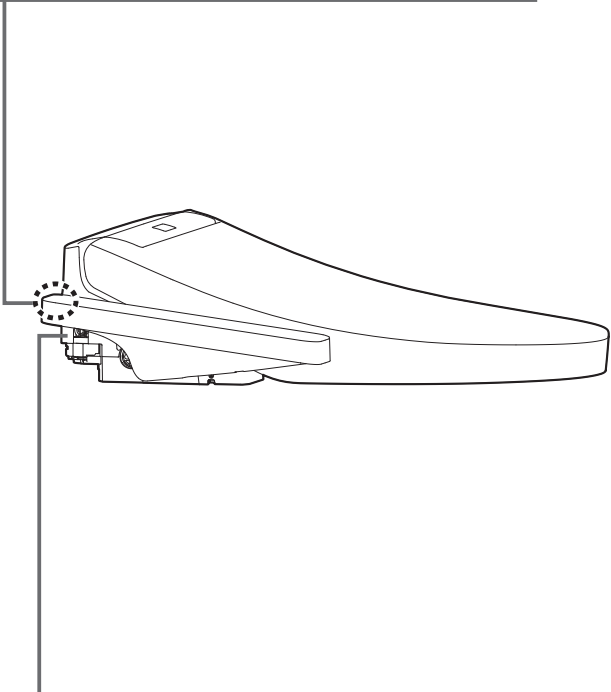

Left side of the main unit

Water filter drain valve (Page 34)

Water drain plug (Page 37)

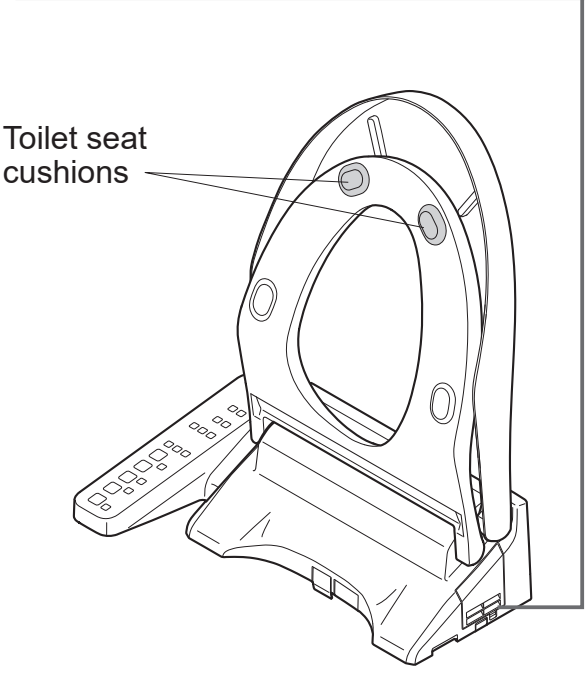

Preparation

Using the Product for the First Time

1. Turn on the power

- 1 Insert the power plug.
 - The wand extends and then retracts.

- 2 Check the "Power" LED illuminates.

- When the "Power" LED does not light, press  for at least 3 seconds.

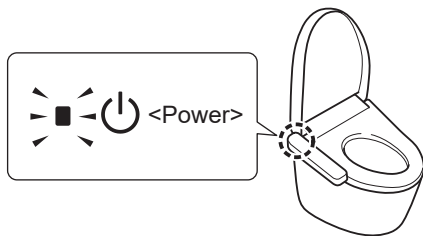

2. Open the shutoff valve

- 1 Fully open the shutoff valve.

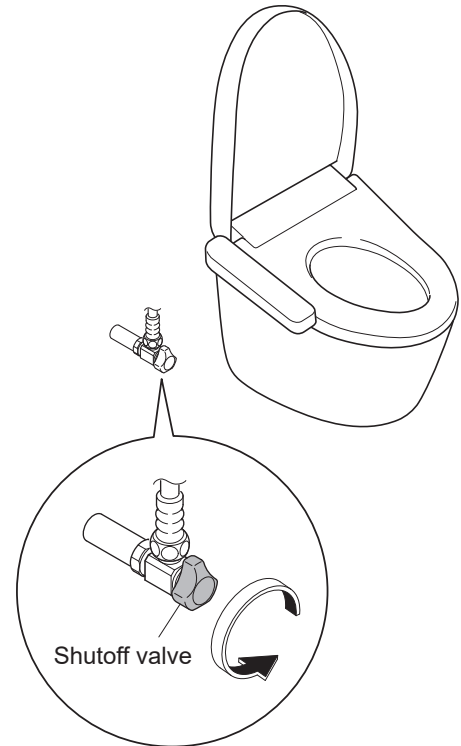

Basic Operation

Mechanism of Auto Functions (SW3074T40, SW3074, SW3073)

"EWATER+" is used automatically to clean the wand.

As you approach



As you sit



As you stand up ^{*1}



0 (sec) 10 25

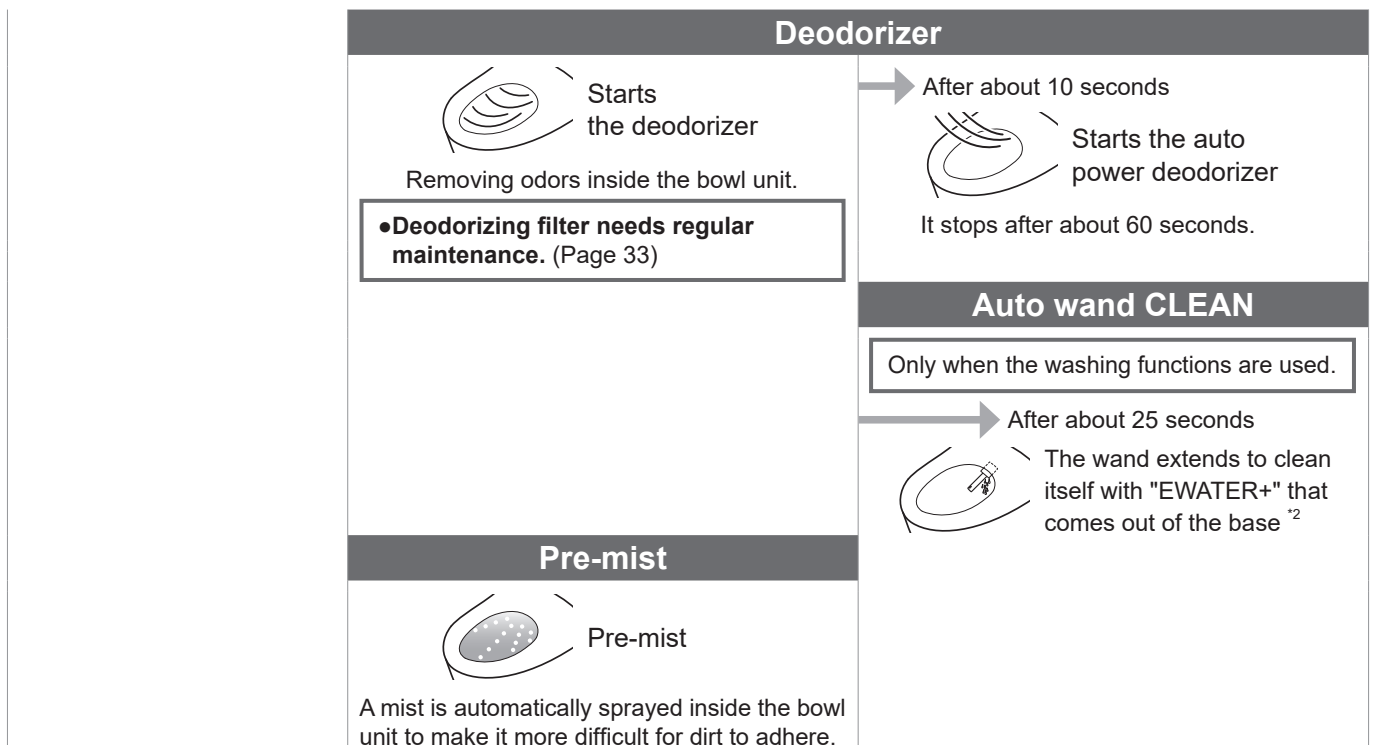

The above are default setting functions.

- These may be changed. → "Various Operations" (Pages 24 - 27)

Auto wand CLEAN

During "Auto wand CLEAN" or "Wand CLEAN"



Flashes

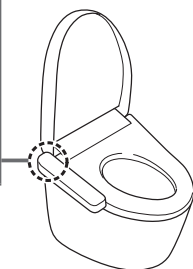

What is meant by "EWATER+" ?

- "EWATER+" helps the self-cleaning wand feature work effectively and by preventing the accumulation of dirt that can cause stains.
- "EWATER+" is generated from chemicals already present in potable water.
 - "EWATER+" helps to minimize dirty surfaces, but does not make cleaning unnecessary.
 - The effect of rinsing with "EWATER+" can vary depending on the frequency of toilet use and other conditions.

"EWATER+" can also be used by pressing the button on the control panel.

■ Wand

Press WAND CLEAN

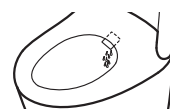

(After wand cleaning, water comes out from around the wand.)

- To clean the wand with it extended. ⇒ "Wand cleaning" (Page 33)

*1 To keep clean the wand every time it is used, water remaining in the wand is drained after you stand up from the toilet seat.

*2 When the washing functions (Rear washing and Front washing etc.) have not been used in 8 hours, the wand is cleaned automatically. (Water comes out from around the wand.)

Using the Control Panel

Washing

"Rear washing"

- Washes your rear.

"Rear soft washing"*³

- Washes your rear with mild water pressure.

"Front washing"

- Serves as a bidet for ladies.

"Oscillating washing"*³

- When you press this button again during use, the wand moves back and forth to wash your rear thoroughly.

Drying

"Warm air drying"

- Dries your rear.

Stopping

"Stop"

- Stops the operation.

"Power deodorizer"*³

Pressing the button increases the deodorizer power

- This button is only enabled when sitting on the toilet seat.
- When you stand up without turning the button off, it automatically stops after about 60 seconds.

"Power ON/OFF"

- Pressing it about 3 seconds or longer turns the power on/off.

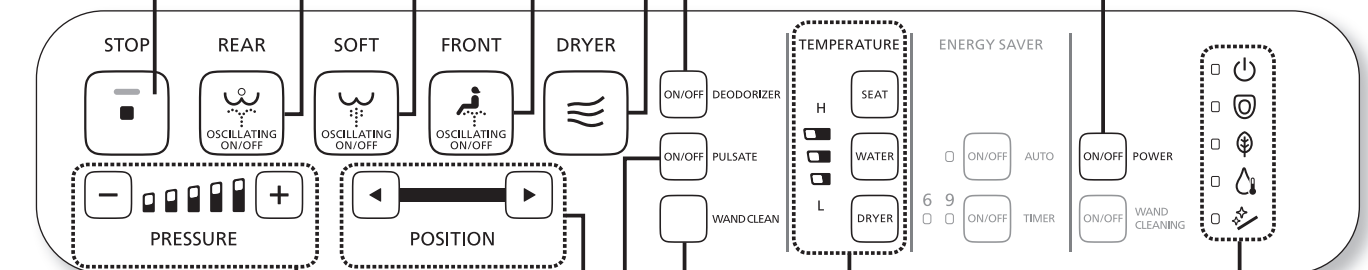

<The drawing is SW3074>

Temperature setting, Temperature adjustment LED (Page 18)
 • Adjust temperatures
 Main display (Page 13)

"Wand CLEAN"*³ (Page 16)

Cleans the wand with "EWATER+".

- This function will operate automatically after using the washing functions (Rear washing, Front washing, etc.). (Page 16)

*³ Except SW3024, SW3023

- Functions that operate when a button is pressed during "Rear washing", "Rear soft washing" or "Front washing".

Note

- Sitting back on the toilet seat makes it easier to adjust the wand position and to reduce splashing.

"Water pressure adjustment"

You can adjust the water pressure to one of five levels.

- The PRESSURE LEDs illuminate when you sit on the toilet seat.

"Pulsating washing"

Washes with the water pressure pulsating between soft and strong.

"Wand position adjustment"

You can adjust the washing position as desired to 5 different points.

- The washing position returns to the standard position (3rd point) when you stand up from the toilet seat.

For your information

- Water may sometimes come out from around the wand when it expands in the warm water tank, but this is normal.
- As the warm water tank of hot-water system is used, the temperature of warm water may become lower if it is continuously consumed.

Temperature Adjustment

Toilet Seat, Warm Water, Drying

Three different temperature levels (High, Medium, Low) and "OFF" setting can be selected.

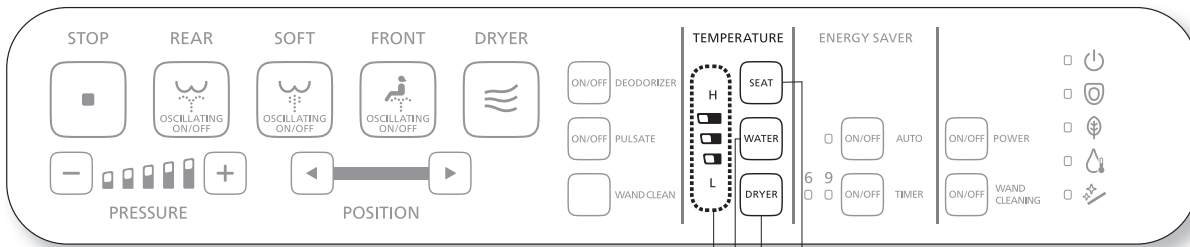

<The drawing is SW3074>

Displaying the temperature level of the pressed button

Warm water temperature button
(When you want to adjust the warm water temperature)

Drying air temperature button
(When you want to adjust the drying air temperature)

Toilet seat temperature button
(When you want to adjust the toilet seat temperature)
When the seat temperature and the warm water temperature are set

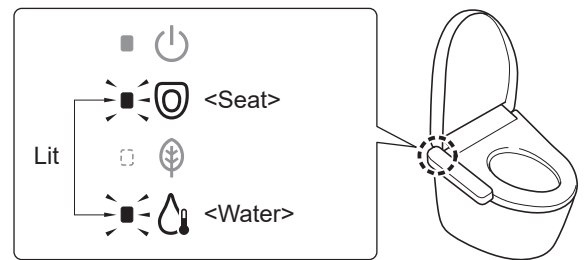

Adjusting the temperature

1 Choose and press the button of the temperature that you want to set from the **SEAT**, **WATER**, **DRYER**.

• The current temperature level appears.

2 Press the button selected in step **1** repeatedly until a desired temperature level illuminates.

The setting changes each time the button is pressed once

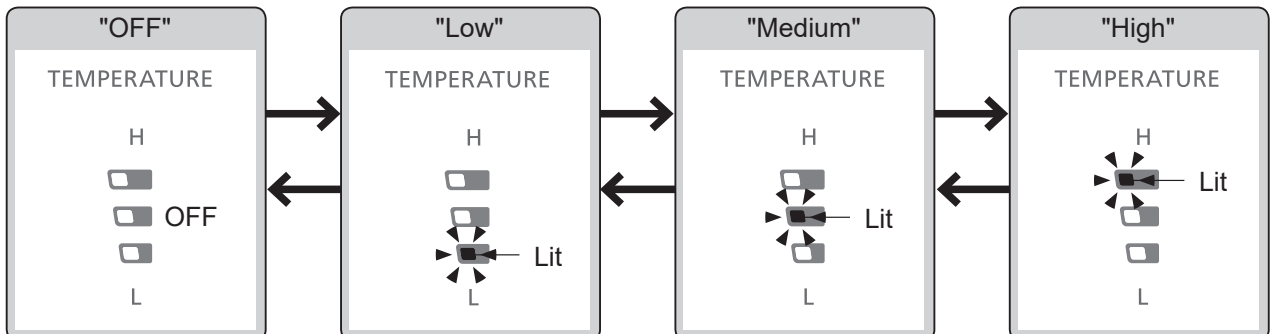

The "Drying" cannot be turned "OFF".

If the button is not pressed for about 10 seconds, the "Temperature adjustment" LED will go off, but the setting will be retained.
If the "Temperature adjustment" LED goes out before the setting is completed, start all over again at step 1.

<Settings complete>

● When the toilet seat does not get warm, or when the warm water is not warm enough, even after temperature adjustment.
→ Is the "Energy saver" set to "ON"? (Pages 20, 21)

When the seat temperature and the warm water temperature are turned "OFF"

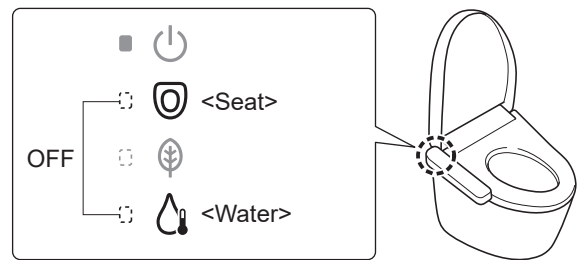

To turn the warm water temperature and toilet seat temperature "OFF"

•The "Drying" cannot be turned "OFF".

1 Select a temperature button you want to turn "OFF"
from **SEAT** , **WATER** and press it.

• The current temperature level appears.

2 Press the button selected in step **1** repeatedly until the temperature level is set to "OFF".

The setting changes each time the button is pressed once

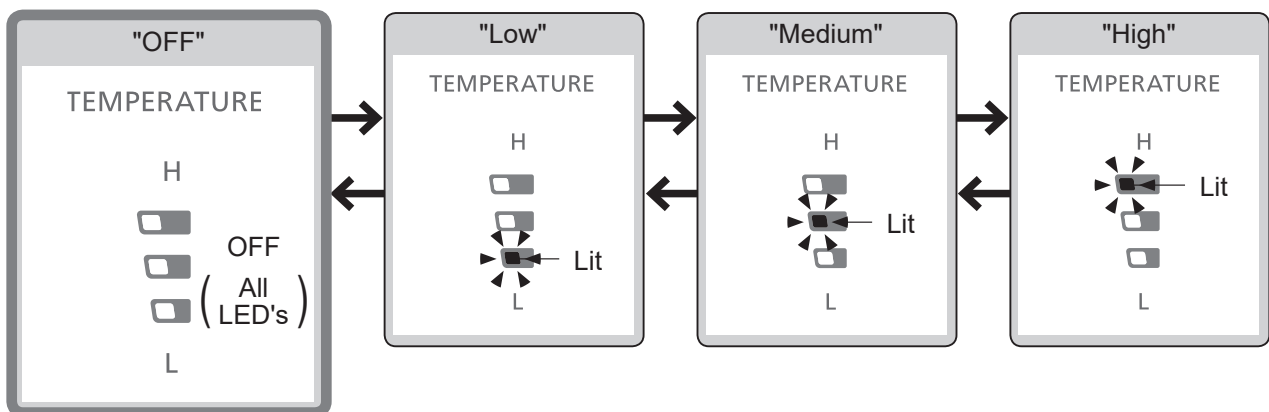

<Settings complete>

Energy Saver Features

Type

"Auto energy saver" or "Timer energy saver" can be selected.

To save energy, lower (or turn "OFF") the seat or warm water temperature.

<p>You want the product to save energy automatically.</p>	<p>You want to save energy only for a preset duration of time. (6 hours, 9 hours)</p>
<p>Auto energy saver</p>	<p>Timer energy saver</p>
<p>The product detects time periods with infrequent use and lowers the toilet seat temperature automatically.</p> <ul style="list-style-type: none"> ● It takes about 10 days for the product to determine the periods when it is used relatively less frequently. 	<p>Once the time is set, the toilet seat heater and warm water heater will be turned off automatically every day at that same time.</p>

When energy saver is in operation

- Main display
- Toilet seat heater
- Warm water heater

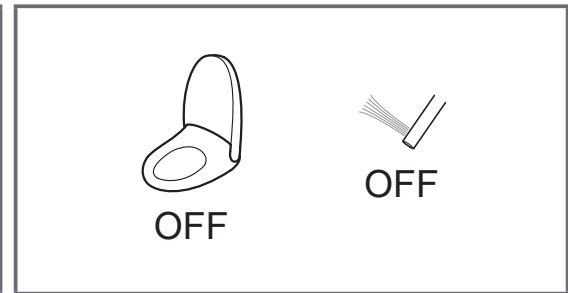
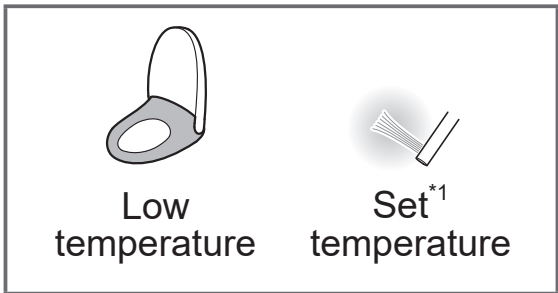
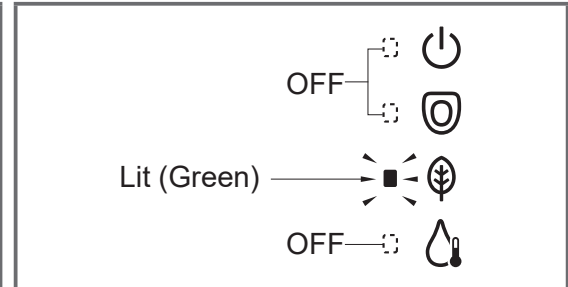
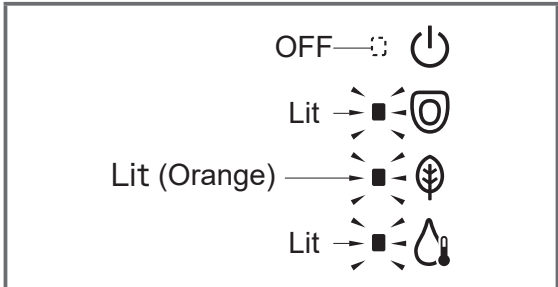

Example

- Set temperature*1
- Low temperature*2
- OFF*3

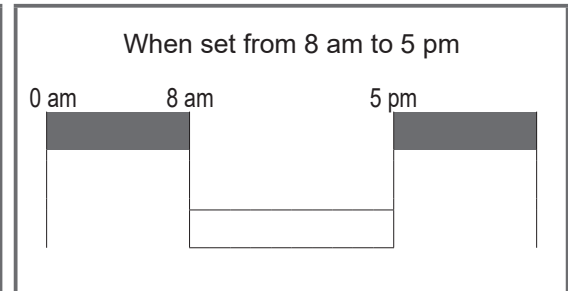
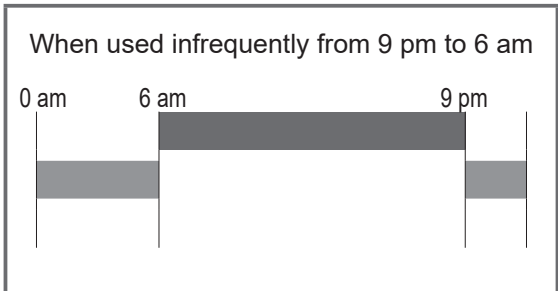

You want to save the maximum amount of energy possible?

Timer energy saver + Auto energy saver

When both "Timer energy saver" and "Auto energy saver" are set, "Auto energy saver" operates when "Timer energy saver" is not operating.

- During "Auto energy saver": Same LED indication as "Auto energy saver"
- During "Timer energy saver": Same LED indication as "Timer energy saver"

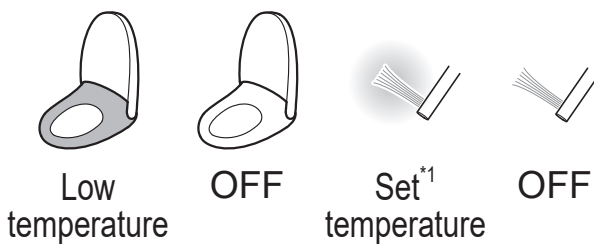

When "Timer energy saver" and "Auto energy saver" are used together

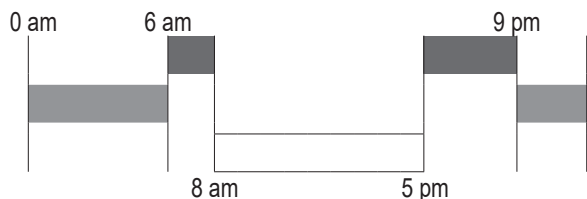

Energy saver is on

- <Power>
- <Seat>
- Lit (Green) → ■ <Energy saver>
- <Water>

Energy saver is off

- <Power>
- <Seat>
- OFF — <Energy saver>
- <Water>

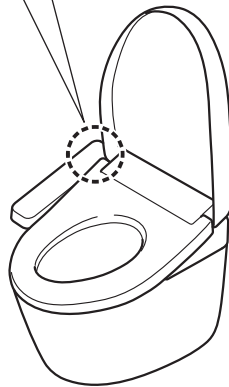

- Even if the energy saver is being activated (with the toilet seat heater set to "Low" or "OFF," or with the warm water heater set to "OFF"), the toilet seat will be temporarily heated when you sit on it. (To reach the setting temperature, the toilet seat takes about 15 minutes and the warm water about 10 minutes, respectively.) (The LED indication on the main display returns to the state for when the energy saver is on.)

*1 The toilet seat temperature settings on pages 18, 19.
 *2 The time period when the toilet seat heater is set to a "Low". The warm water heater is "Set temperature".
 *3 The time period when the toilet seat heater and warm water heater are "OFF".

To set energy saver Pages 22, 23

Energy Saver Features

How to Set

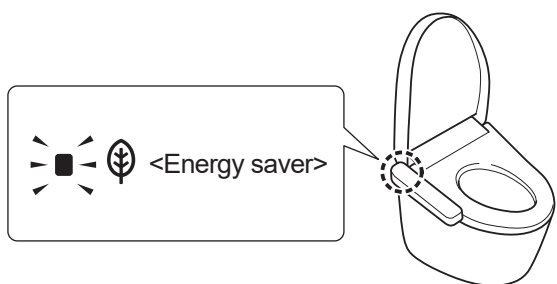
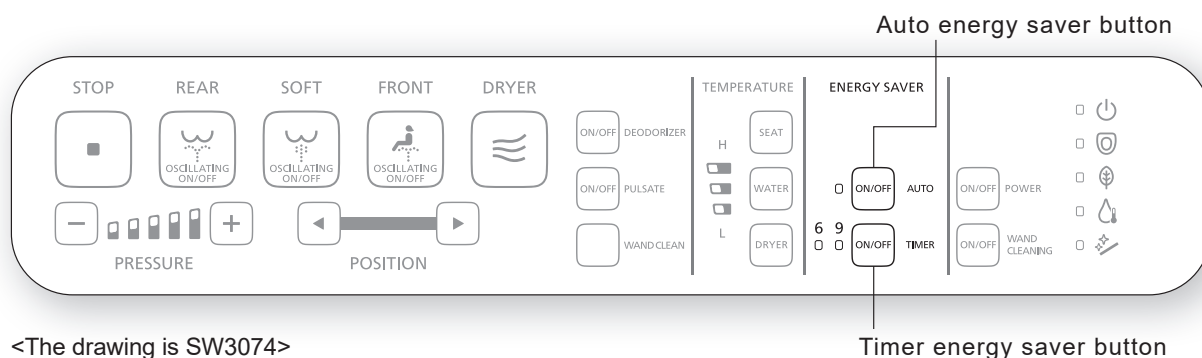

When energy saver is set, the "Energy saver" LED (green) illuminates.

Auto energy saver

1 Press  .

The setting changes each time the button is pressed once

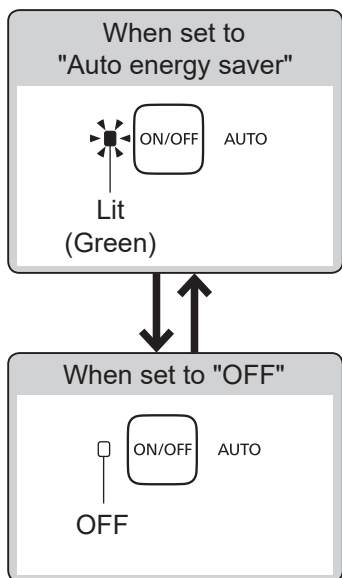

<Settings complete>

Timer energy saver

● Set the Energy saver at the time you want to start it.
Example: To save energy from 1 am to 7 am (for 6 hours)

1 When the time of the day reaches 1:00 am at night,
Press  .

• Press the "Timer energy saver" button repeatedly until the "6" LED illuminates.

The setting changes each time the button is pressed once

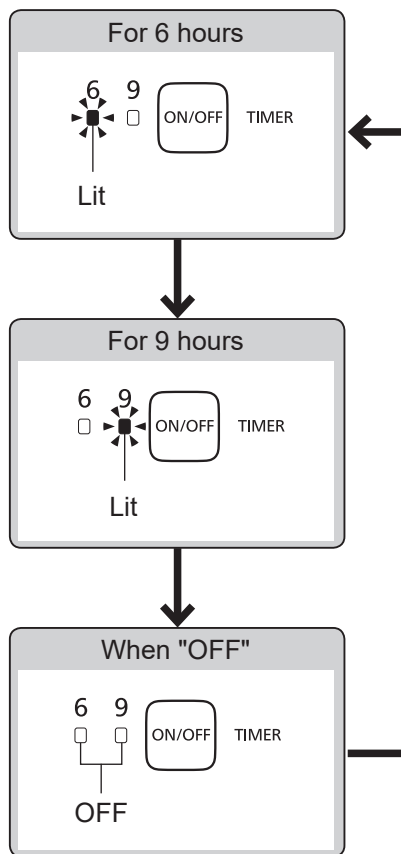

<Settings complete>

Various Operations

Setting List

Setting Types		Available Settings	
		• Bold: Initial settings	
Auto functions	Cleaning Features	Auto wand CLEAN	ON / OFF
		Pre-mist	ON / OFF
		Deodorizer	ON / OFF
		Auto power deodorizer	ON / OFF

Check first!

<The drawing is SW3074>

Buttons used for setting

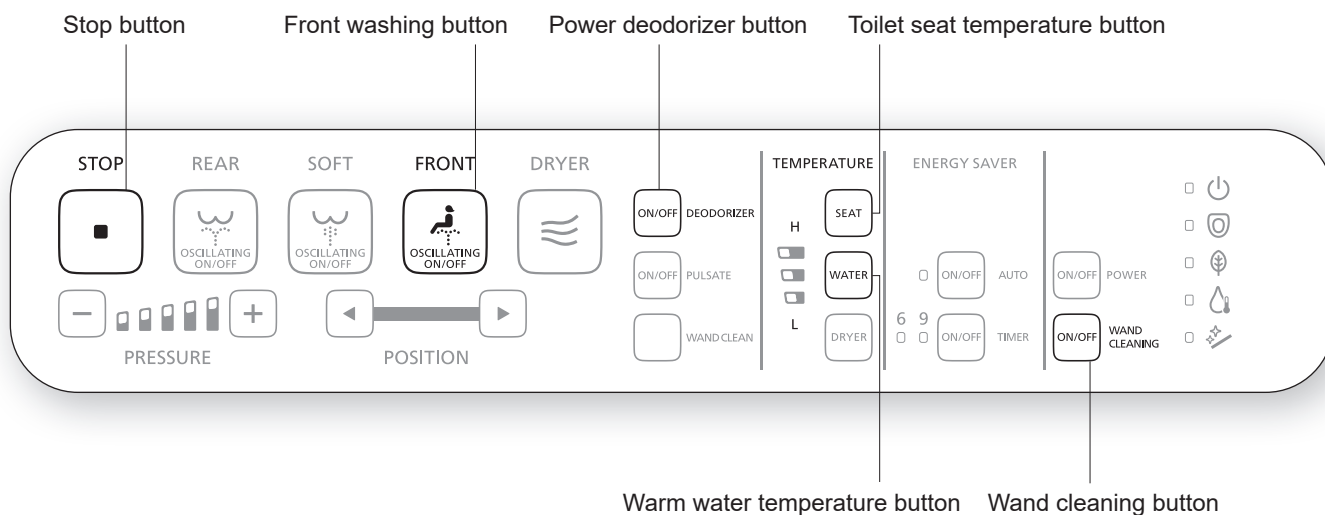

Settings	Applicable Models	How to Set Ref. Page
<ul style="list-style-type: none"> Set whether or not to clean the wand automatically 	SW3074T40 SW3074 SW3073	Page 26
<ul style="list-style-type: none"> Set whether or not to spray mist in the bowl unit automatically 		Page 27
<ul style="list-style-type: none"> Set whether or not to deodorize automatically after sitting on the toilet seat 		
<ul style="list-style-type: none"> Set whether or not to power deodorize automatically after standing up 		

LED indication during setting

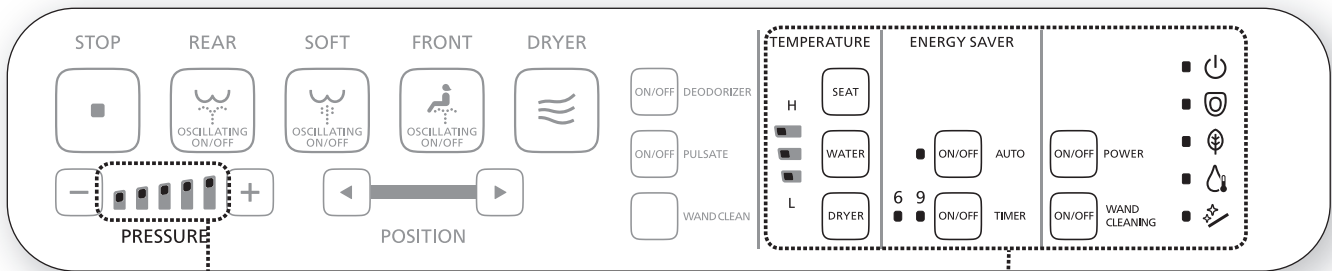

[When the "Stop" button is pressed for at least 10 seconds]
 All control panel LEDs flash *1

*1 During setting, if the next button is not pressed within about 60 seconds, the light will stop flashing. If you fail to complete the setting, redo from the step 1.

Various Operations

Auto functions

Cleaning Features

Set whether or not to clean the wand automatically

Auto wand CLEAN^{*1}

Set whether or not to spray mist in the bowl unit automatically

Pre-mist

1 



Press (for about 10 seconds) until all control panel LEDs flash.

2 Press  and  at the same time.

The setting changes each time the button is pressed once

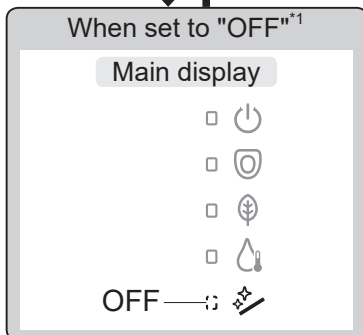
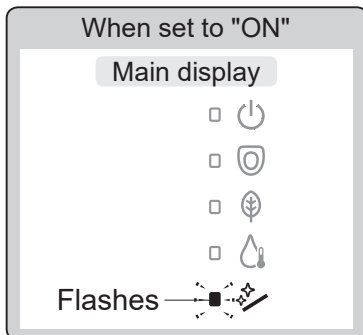
Set whether or not to clean the wand automatically



2 Press  and  at the same time.

The setting changes each time the button is pressed once

Set whether or not to spray mist in the bowl unit automatically

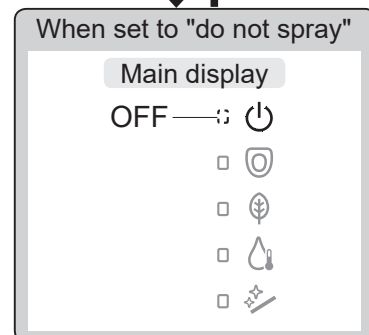
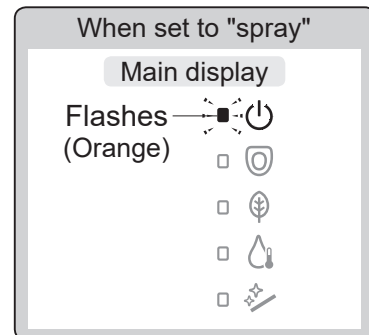

3 Press  .

<Settings complete>

*1 When "Auto wand clean" is set to "OFF", the "Wand CLEAN" LED turns off.

Cleaning Features

Set whether or not to deodorize automatically after sitting on the toilet seat

Deodorizer

Set whether or not to power deodorize automatically after standing up

Auto power deodorizer

1  Press (for about 10 seconds) until all control panel LEDs flash.

2 Press .

The setting changes each time the button is pressed once

Set whether or not to deodorize automatically after sitting on the toilet seat

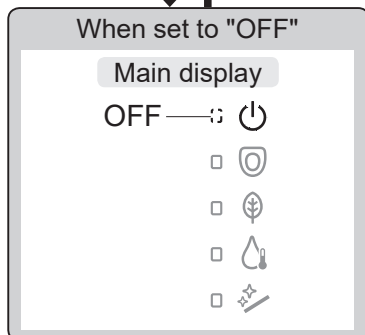
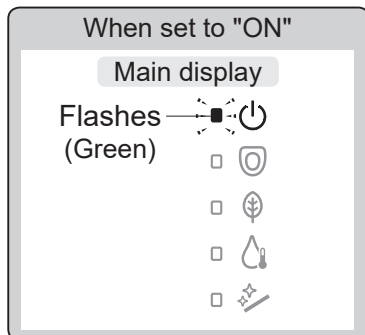

2 Press .

The setting changes each time the button is pressed once

Set whether or not to power deodorize automatically after standing up

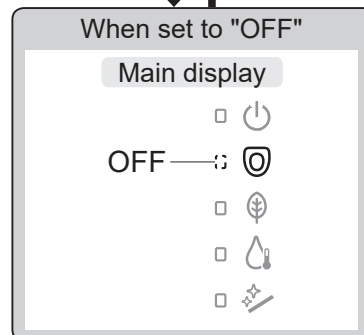
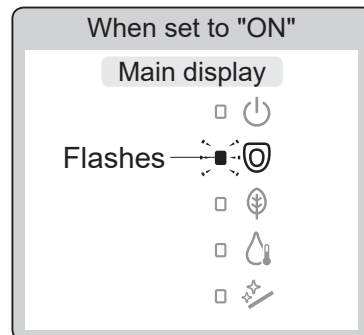

3 Press .

<Settings complete>

Maintenance

Power Plug

Power Plug (Approximately once a month)

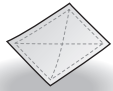

Dry cloth



Wet cloth

- 1 Unplug the power plug and wipe it with a dry cloth.



- 2 Insert the power plug.
 - The "Power" LED illuminates.

! WARNING

- Periodically remove dust from the blades and other parts of the power plug.
 - Unplug the power plug and wipe it with a dry cloth.
- Fully insert the power plug.
- When unplugging the power plug, hold the main body of the power plug.
 - Pulling the power cord may damage the power plug or power cord.



! WARNING

- ! Always unplug the power plug from the outlet before maintenance or inspection.

(Failure to do so may cause electric shock or malfunction, resulting in a breakdown.)

For safety, unplug the power plug before maintenance. ^{*1 *2}

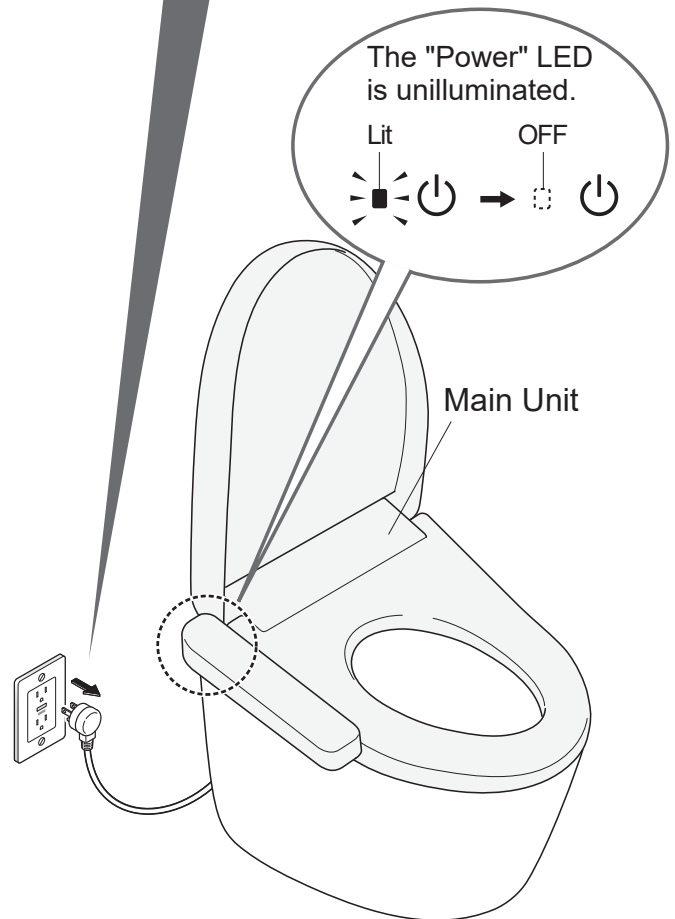

Do not use a dry cloth or toilet paper on plastic parts. (May cause damage.)



*1 Except when using "Wand cleaning".

*2 Remove the power plug from the outlet to cancel timer energy saver settings. Set them again. (Page 23) (The "Timer energy saver" LED for the set time flashes to notify you.)

Main Unit

Main Unit (Approximately daily)



Soft cloth
soaked in water

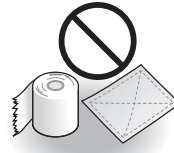

- Toilet paper
- Dry cloth
- Nylon scrubbing brush
(May cause damage)

1 Unplug the power plug.

2 Wipe with a soft cloth that has been soaked in water and wrung out thoroughly.

■ **For heavy dirt**

- Wipe with a soft cloth soaked in diluted, pH neutral kitchen detergent, and then wipe with a soft cloth soaked in water.



PH neutral kitchen detergent



- Paint thinner
- Benzene
- Powdered cleanser

3 Insert the power plug.

- The "Power" LED illuminates.

Attention!

- This product is an electric appliance. Be careful not to let water seep inside or leave detergent in the gap between the main unit and bowl unit. (May damage plastic parts or cause a malfunction.)
- When using a toilet cleaner to clean the toilet, rinse it off within 3 minutes and leave the toilet seat and toilet lid open.
 - Wipe off any cleaner that remains on the bowl unit.
(If vapor from a toilet cleaner enters the main unit, it may cause a malfunction.)
- Do not push or pull the covers around the wand with undue force.
(May cause damage or malfunction.)
- Wipe the back surface of the toilet seat and the toilet seat cushions with a soft cloth tightly wrung out with water.
(Otherwise adhesion of dirt may result in discoloration.)

[SW3074T40]

Gap between the Main Unit and Bowl Unit (Approximately once a month)

You can remove the main unit to clean the top of the bowl unit and the bottom of the main unit.



Soft cloth soaked in water

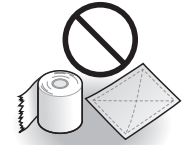

Toilet paper, etc. (May cause damage.)

1 Unplug the power plug.

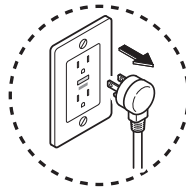

If the power is not unplugged, the product may malfunction or cause a failure or electric shock.

2 Remove the main unit.

• Do not pull the unit with undue force. (because the water supply hose and power cord are attached.)

- (1) Pull the main unit toward you while pressing the "Main unit removal button". (2) Lift up the main unit.

• Do not excessively bend the water supply hose.

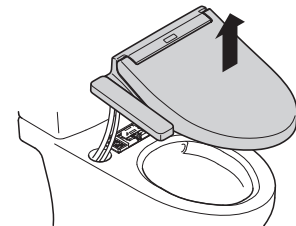
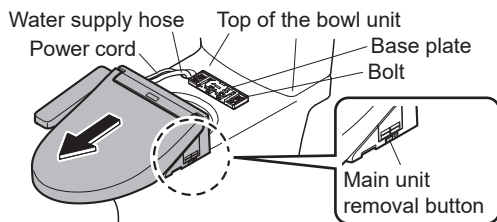

3 Clean the top of the bowl unit and the bottom of the main unit.

• Wipe with a soft cloth soaked in a diluted, pH neutral kitchen detergent. Then, dry the surface with a soft cloth soaked in water so that no detergent remains.

4 Mount the main unit.

- (1) Lift the main unit, then lower it straight down while threading the power cord and water supply hose into the recess on the bowl unit.

• Be careful not to pinch the power cord.
• Do not excessively bend the water supply hose

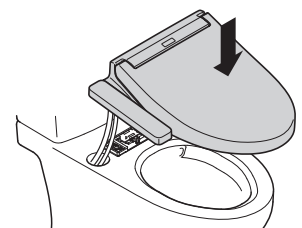

- (2) Align the main unit with the center of the base plate and press it firmly onto the base plate until a click sound is heard.

CAUTION

! Push the main unit firmly on to the base plate until a click sound is heard.
(Doing so may cause the main unit to come loose and fall, resulting in injury.)

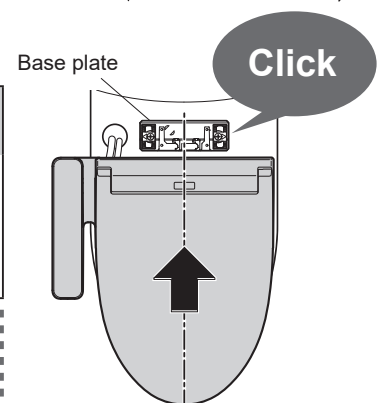

After mounting, check that the main unit does not detach even when pulled.

5 Insert the power plug.

• The "Power" LED illuminates.

[SW3074, SW3024, SW3073, SW3023]

Gap between the Main Unit and Bowl Unit (Approximately once a month)

You can remove the main unit to clean the top of the bowl unit and the bottom of the main unit.

1 Unplug the power plug.

2 Remove the main unit.

- Do not pull the unit with undue force. (because the water supply hose and power cord are attached.)

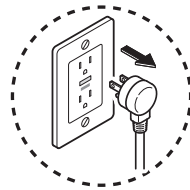

Soft cloth soaked in water



Toilet paper, etc. (May cause damage.)

If the power is not unplugged, the product may malfunction or cause a failure or electric shock.

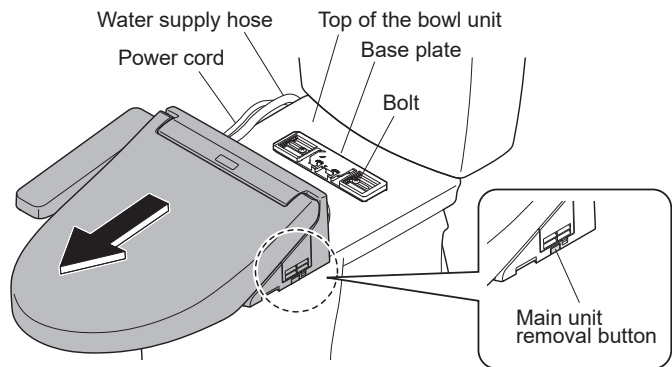

Pull the main unit toward you while pressing the "Main unit removal button".

3 Clean the top of the bowl unit and the bottom of the main unit.

- Wipe with a soft cloth soaked in a diluted, pH neutral kitchen detergent. Then, dry the surface with a soft cloth soaked in water so that no detergent remains.

4 Mount the main unit.

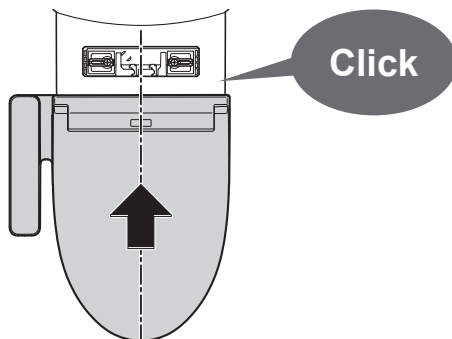

Align the main unit with the center of the base plate and press it firmly onto the base plate until a click sound is heard.

5 Insert the power plug.

- The "Power" LED illuminates.

CAUTION

-  Push the main unit firmly on to the base plate until a click sound is heard. (Doing so may cause the main unit to come loose and fall, resulting in injury.)

After mounting, check that the main unit does not detach even when pulled.

Gap between the Main Unit and the Toilet Lid (Approximately once a month)

The toilet lid can be removed for thorough cleaning.

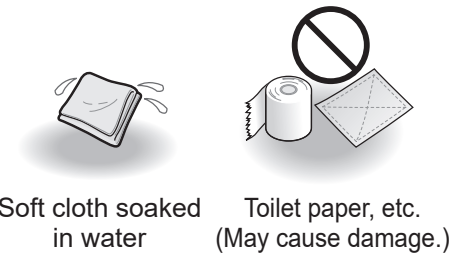

Soft cloth soaked in water

Toilet paper, etc. (May cause damage.)

1 Unplug the power plug.

2 Remove the toilet lid.

Slightly tilt the toilet lid to the front.

Ⓐ : Pull the left side outward.

Ⓑ : Disconnect the hinge from the recess and pull up.

Ⓒ : Disconnect the right side.

3 Wipe with a soft cloth that has been soaked in water and wrung out thoroughly.

4 Reinstall the toilet lid.

Ⓓ : Join the pin and the hinge on the right side.

Slightly tilt the toilet lid to the front.

Ⓐ : While pulling out the left side,

Ⓔ : Mount by joining the hinge with the recess.

* Be careful not to pinch your fingers.

5 Insert the power plug.

• The "Power" LED illuminates.

6 Open and close the toilet lid to check the reinstallation.

Removing and Reinstalling

Hold with both hands

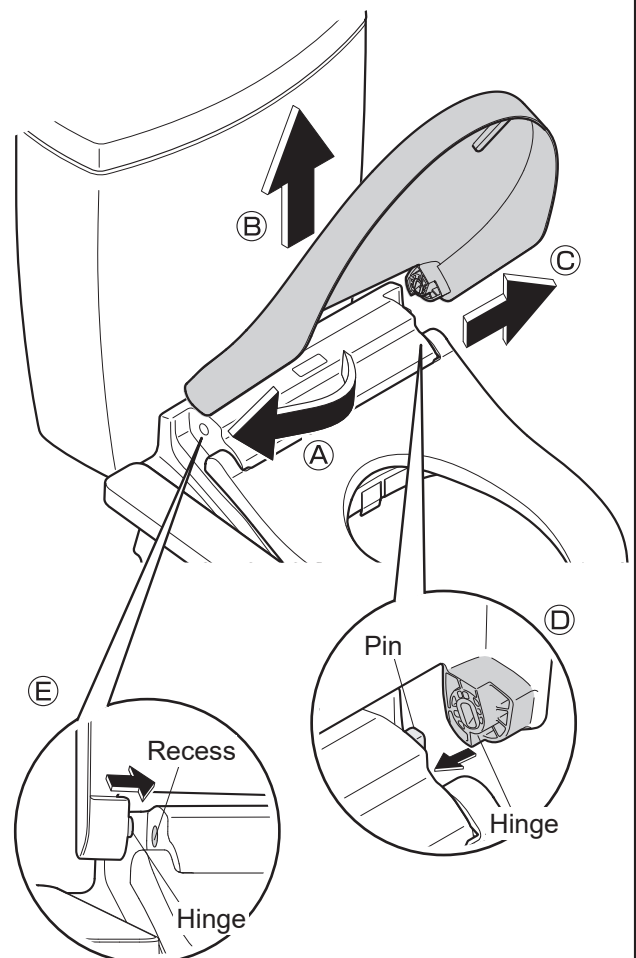

Deodorizing Filter

Wand

Deodorizing Filter (Approximately once a month)*1

1 Unplug the power plug.

2 Remove the deodorizing filter.

- Hold the tab and pull outward.
- Do not pull with undue force. (Doing so may cause damage or malfunction.)

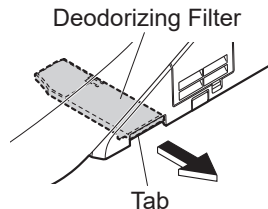

3 Clean with a tool such as a toothbrush.

- When washing with water, dry off all water before reinserting.

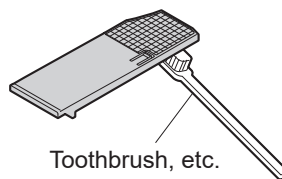

4 Reinsert the deodorizing filter.

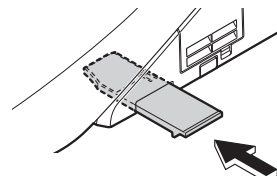

5 Insert the power plug.

- The "Power" LED illuminates.

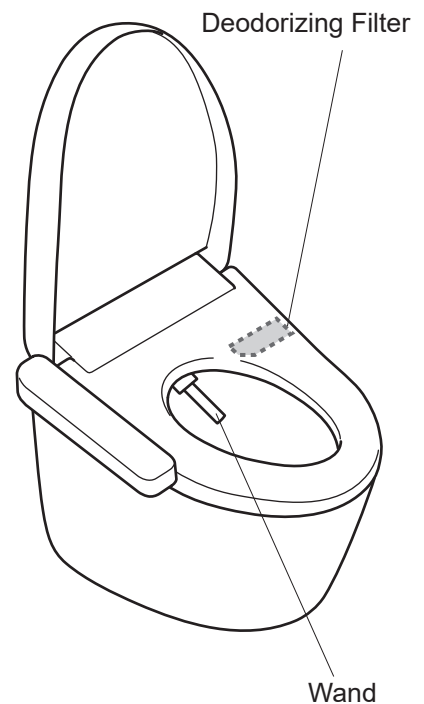

Wand (Approximately once a month) <If you notice dirt (Wand cleaning)>

1 Press WAND CLEANING .

- The wand extends and water flows out for cleaning.
- The wand automatically retracts after about 5 minutes.



2 Wipe with a soft, wet cloth.

- Do not pull, push or press the wand with excessive force. (May cause damage or malfunction.)

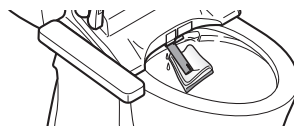

3 Press WAND CLEANING .

- The wand retracts.

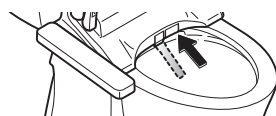

*1 Except SW3024, SW3023

Water Filter Drain Valve (Approximately once every 6 months)

<If you think the water pressure has weakened>

- 1** Close the shutoff valve.
 - The water supply stops.

CAUTION

-  Do not remove the water filter drain valve while the shutoff valve is open.
(Otherwise, water may leak out)

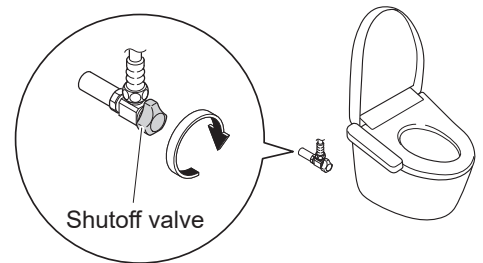

- 2** Press  to extend the wand, and then press  again to return the wand.

(Release the pressure from the water supply pipe.)

- 3** Unplug the power plug.

- 4** Remove the water filter drain valve.

- Loosen the water filter drain valve with a flat-head screwdriver and then pull it.

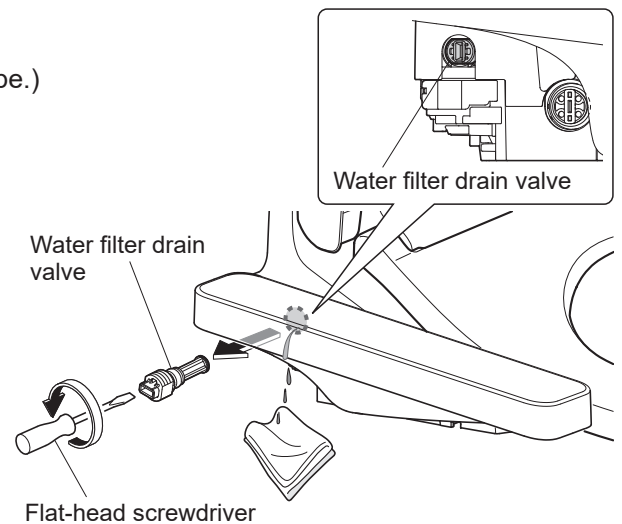

- 5** Clean with a tool such as a toothbrush.

- Also, remove any dust from inside the hole of the water filter drain valve.

- 6** Reinstall the water filter drain valve.

- Insert the water filter drain valve and use a flat-head screwdriver to tighten it securely.

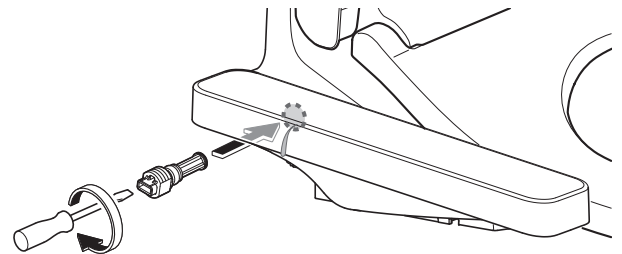

- 7** Insert the power plug.

- The "Power" LED illuminates.

- 8** Open the shutoff valve. (Page 14)

What to Do?

If the water does not flow due to a water service interruption

If the water does not flow due to a water service interruption

Make sure to also check the instruction manual of your bowl unit.

- 1** Use a bucket to flush water.
- 2** If the water level is low after flushing, add more water.
(Until the water level does not rise)
 - Prevents odors.

Attention!

- When the water supply is restored, be sure to perform a flush.
(To prevent waste from remaining in the drain pipe.)

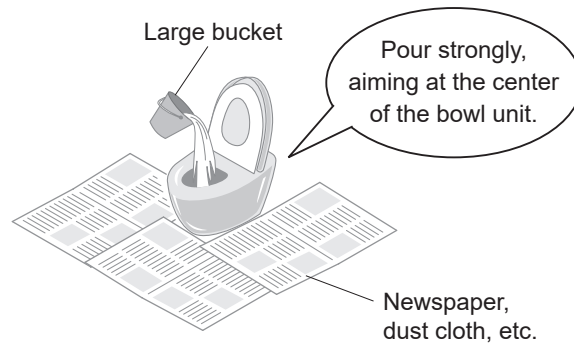

What to Do?

Freeze Damage Prevention

When the ambient temperature is likely to drop to 32 °F (0 °C) or lower, take measures to prevent freezing.

Attention!

- When the ambient temperature is likely to drop to 32 °F (0 °C) or lower, do not use the energy saver feature. (May damage the product.)
- Warm the bathroom or take measures against freezing so that the ambient temperature does not drop below 32 °F (0 °C).

How to freeze damage prevention

1 Close the shutoff valve. (Page 34)

- The water supply stops.



CAUTION



Do not remove the water filter drain valve while the shutoff valve is open. (Otherwise, water may leak out)

2 Drain the water from the toilet tank.

- Manipulate the lever/button/etc. until the water stops.

3 Press to extend the wand, and then press again to return the wand.

(Release the pressure from the water supply pipe.)

4 Unplug the power plug.

5 Drain the pipe.

(1) Remove the water filter drain valve.

- Loosen the water filter drain valve with a flat-head screwdriver and then pull it.

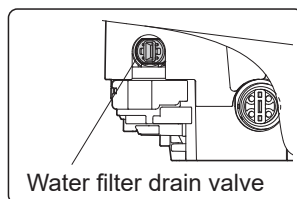

Flat-head screwdriver

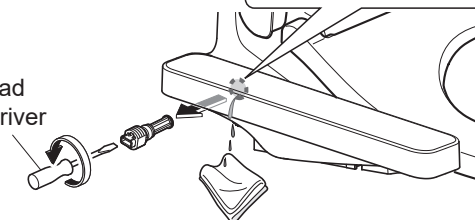

(2) [Applicable to SW3074, SW3024, SW3073, SW3023 only]

- Drain the water from the water supply hose.

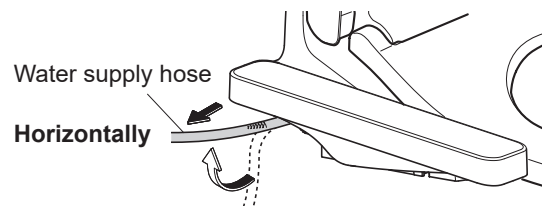

(3) When water draining is completed, reinstall the water filter drain valve.

- Insert the water filter drain valve and use a flat-head screwdriver to tighten it securely.

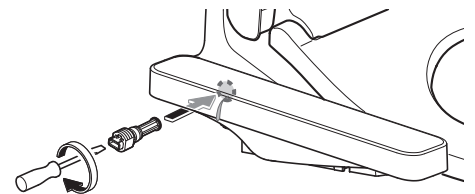

6 Insert the power plug.

- The "Power" LED illuminates.

7 Set the water and toilet seat temperature to "High". (Page 18)

- To maintain the temperature, close the toilet seat and toilet lid after finishing work.

■ To use the product again



- The water needs to be resupplied. (Page 37)

Long Periods of Disuse

If the toilet is in a location you will not visit for a long time, drain the water.
(Failure to do so may cause breakdown or skin irritation due to polluted product tank water.)

How to drain the water

1 Drain the water from the toilet tank.
(Page 36 Step **1** **2**)

2 Press  to extend the wand, and then press  again to return the wand.
(Release the pressure from the water supply pipe.)

3 Unplug the power plug.

4 Drain the pipe. (Page 36 Step **5**)

5 Loosen the water drain plug until water comes out from around the wand.

- Water comes out from around the wand. (It takes about 3 minutes to complete draining.)
- * The water drain plug cannot be removed.

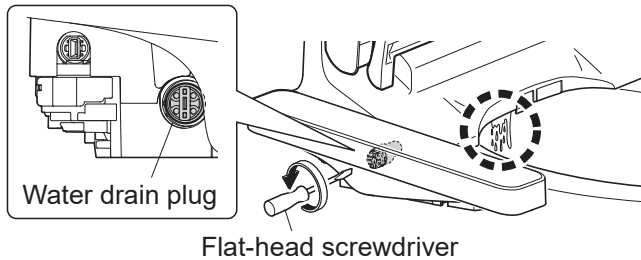

6 Tighten the water drain plug securely with a flat-head screwdriver.

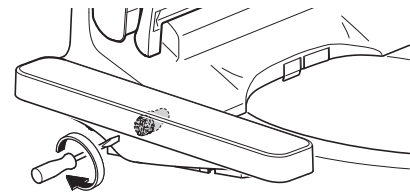

■ If water may get frozen

- Add antifreeze solution to the water in the bowl to prevent freezing. (The antifreeze solution should not be flushed out. Collect it before using the toilet and dispose of it.)

■ To use the product again

- The water needs to be resupplied. (See below)

Resupplying the Water

- 1** Open the shutoff valve.
 - Check that water is not leaking from a pipe or the main unit.
- 2** If the power is not on, Insert the power plug.
 - The "Power" LED illuminates.
- 3** Discharge water from the wand.
 - (1) Pressing down the left side of the toilet seat,
 - (2) Press "Rear washing" button on the control panel to discharge water from the wand for about 2 minutes.
 - It takes about 1 minute maximum before water comes out.
 - Catch the water in a paper cup or other receptacle.
 - (3) Press the "Stop" button on the control panel.

■ If the remaining water has frozen and no water comes out

- Heat the inside of the bathroom, and warm the water supply hose and shutoff valve using a cloth soaked in warm water.

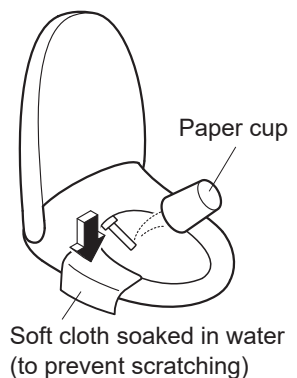

Troubleshooting

First, try the actions described on pages 38 - 41.
If the problem persists, consult the installer, seller, or
TOTO customer service.
(see contact information on the back cover.)

⚠ CAUTION

! If a water leak occurs, close the shutoff valve.

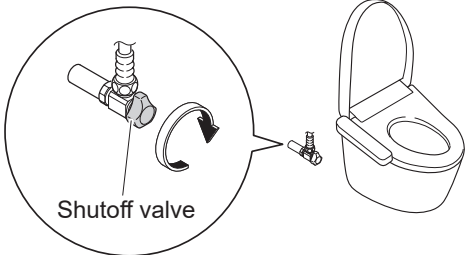

Shutoff valve

Please check first

Is the Power LED illuminated?

- **Is the breaker on the distribution board turned on?**
→ Check whether there is a power outage or the breaker has turned "OFF".
- **Is the "Power ON/OFF" setting "OFF"?**
→ Switch it to "ON" with the control panel. (Page 14 Step1-2)
- **Is the "Power" LED on the main display flashing?***
→ The main unit is not mounted properly. Mount them correctly again. (Pages 30, 31)

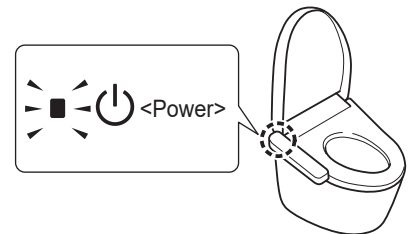

Is the Energy saver LED illuminated?

- **While the LED is illuminated, energy saver** (Pages 20, 21) **is in operation, so the toilet seat temperature may be reduced or the warm water heater and toilet seat heater may be turned off.**

Rear washing, Rear soft washing*1, Front washing and Wand

Trouble	Please check	Ref. Page
The wand (or washing water) does not come out	<ul style="list-style-type: none"> ● Has the toilet been sat on and used continuously for 2 hours or longer? (If so, operation is stopped for safety purposes.) →Stand up from the seat and then use again. 	-
	<ul style="list-style-type: none"> ● The seat switch will not turn on unless you sit on the seat properly. →Sit back on the toilet seat. 	11
	<ul style="list-style-type: none"> ● Are you using a toilet seat cover, a toilet lid cover or a seat for infants? →Remove any covers. When using a seat for infants or a soft highchair, remove after each use. 	 Covers 11
	<ul style="list-style-type: none"> ● Are you pressing "Wand CLEAN" button?¹ <ul style="list-style-type: none"> • When you press "Wand CLEAN" button, "EWATER+" comes out from the vicinity of the wand to clean the wand. →To clean the wand with it extended, perform "Wand cleaning". 	33
The wand extends but the washing water does not come out / The washing water pressure is weak	<ul style="list-style-type: none"> ● Has a water failure occurred? →Press "Stop" button on the remote control and wait until water service is restored. 	-
	<ul style="list-style-type: none"> ● Is the shutoff valve closed? →Fully open the shutoff valve. 	14
	<ul style="list-style-type: none"> ● Is the water filter drain valve clogged with foreign matter? →Clean the filter. 	34
	<ul style="list-style-type: none"> ● Is the water pressure set to a low level? 	17
	<ul style="list-style-type: none"> ● Is the water drain plug loosened? →Tighten the water drain plug securely. 	37
The washing water is cold	<ul style="list-style-type: none"> ● Is the warm water temperature set to "OFF" or a low level? ● When the temperature of the water supply or the bathroom is low, the water temperature may be low when first sprayed. ● Is the timer energy saver in operation? <ul style="list-style-type: none"> • The energy saver feature is on when the "Energy saver" LED is on and the "Power" LED is off on the main display. 	18 - 20, 21
	<ul style="list-style-type: none"> When you sit on the seat, the warm water heater is temporarily turned on and water is warmed in about 10 minutes. →When the timer energy saver is set to "ON", you can also turn it "OFF". 	23
Wash functions stop unintentionally during use	<ul style="list-style-type: none"> ● "Rear washing", "Rear soft washing"¹ and "Front washing" stop automatically after 5 minutes of continuous use. ● Does the seat switch have difficulty detecting? →Sit back on the toilet seat. If you get up slightly from the seat, or sit forward on the seat, the seating switch may temporarily stop detecting your presence. 	- 11
Water comes out unexpectedly from the wand	<ul style="list-style-type: none"> ● Water may sometimes come out from around the wand when it expands in the warm water tank. ● Is the "Wand CLEAN" LED on the main display flashing?¹ →"Auto Wand CLEAN" starts and the wand is being cleaned. 	- 16

*1 Except SW3024, SW3023

Troubleshooting

Warm air drying

Trouble	Please check	Ref. Page
The dryer temperature is low	<ul style="list-style-type: none"> ● Is the dryer temperature set to low level? 	18
Stops in the middle of use	<ul style="list-style-type: none"> ● The feature stops automatically after about 10 minutes of continuous use. ● Does the seat switch have difficulty detecting? → Sit back on the toilet seat. If you get up slightly from the seat, or sit forward on the seat, the seating switch may temporarily stop detecting your presence. 	- 11

Toilet Seat and Toilet Lid

Trouble	Please check	Ref. Page
The toilet seat is cold	<ul style="list-style-type: none"> ● Is the toilet seat temperature set to "OFF" or a low level? 	18
	<ul style="list-style-type: none"> ● Is energy saver in operation? <ul style="list-style-type: none"> • The energy saver feature is on when the "Energy saver" LED is on and the "Power" LED is off on the main display. When you sit on the seat, the toilet seat heater is turned on temporarily and the seat is warmed in about 15 minutes. → You can turn it "OFF" if the energy saver feature is "ON". 	20, 21 23
	<ul style="list-style-type: none"> ● Have you been seated for a long time? <ul style="list-style-type: none"> • After about 20 minutes of sitting, the temperature starts reducing, and after about 1 hour, the toilet seat heater is turned "OFF". → Stand up from the seat and then use again. ● Did you put anything on the toilet seat or the toilet lid? → Remove anything placed on top of the toilet seat or lid. 	- -
	<ul style="list-style-type: none"> ● Is a toilet lid or seat cover installed? → Remove any covers. 	11

Energy Saver

Trouble	Please check	Ref. Page
The timer energy saver feature is not working	<ul style="list-style-type: none"> ● Did you unplug the power plug or was there a power outage? <ul style="list-style-type: none"> • The setting is cancelled. → Set them again. (When the power is turned off once, the "Timer energy saver" LED flashes to notify you.) 	23
The auto energy saver feature is not working	<ul style="list-style-type: none"> ● Because this function takes several days learning the usage conditions before starting energy saver, the amount of energy saving may be low, depending on the frequency of use. → Check the energy saver setting. 	20, 21

Deodorizer*1

Trouble	Please check	Ref. Page
The deodorizer seems to be not working	<ul style="list-style-type: none"> ● Is "Deodorizer" set to "OFF"? → Set to "ON". ● Even after sitting down, you do not hear operation sounds. → Sit back on the toilet seat. If you hear an operation sound when you sit on the toilet seat. → Clean the deodorizing filter. 	27 - 33

Deodorizer*1

Trouble	Please check	Ref. Page
A strange odor is emitted	<ul style="list-style-type: none"> ● Are you using an air freshener or deodorizer that you purchased separately? <ul style="list-style-type: none"> • Doing so may reduce the effectiveness of the product's deodorizer or cause strange odors. → Remove the air freshener or deodorizer. 	-
The auto power deodorizer feature is not working	<ul style="list-style-type: none"> ● Is "Auto power deodorizer" set to "OFF"? → Set to "ON". ● It starts about 10 seconds after you stand up from the toilet seat. 	27 -

Sanitary*1

Trouble	Please check	Ref. Page
The Wand CLEAN LED does not illuminate	<ul style="list-style-type: none"> ● If the "Wand CLEAN" LED does not illuminate, it is time to replace the component that generates "EWATER+". Consult the installer, seller, or TOTO customer service. (see contact information on the back cover.) 	-

Others

Trouble	Please check	Ref. Page
Water is leaking from the plumbing connections	<ul style="list-style-type: none"> ● If the nut of the connecting pipe is loosened, retighten it by hand. (Do not use any tool.) → If the water leak does not stop, close the shutoff valve and consult with TOTO customer service. (see contact information on the back cover.) 	-
The main unit is unstable	<ul style="list-style-type: none"> ● There is clearance between the toilet seat cushion and the bowl unit for activating the seat switch. When you sit on the toilet seat, the toilet seat subsides slightly to activate the seat switch. ● Are the bolts that anchor the main unit loose? → Remove the main unit and then firmly tighten the base plate bolts. 	11 30, 31
The main unit makes a sound*1	When sitting on the toilet seat	
	<ul style="list-style-type: none"> ● When "Pre-mist" is "ON", you hear operation sounds for preparing the pre-mist or spraying mist in the bowl unit. → You can turn it "OFF". 	16 26
	When moving away from the bowl unit after use	
	<ul style="list-style-type: none"> ● When "Auto power deodorizer" is "ON", operation sounds are made while the deodorizing power increases for 60 seconds after you stand up from the toilet seat. → You can turn it "OFF". ● If "Auto wand CLEAN" is "ON" and you use the washing functions (e.g., Rear washing and Front washing), you may hear that the wand is extended and cleaned with "EWATER+". → You can turn it "OFF". 	27 26
The timer energy saver LED is flashing	When not using the product (e.g., at night)	
	<ul style="list-style-type: none"> ● If "Auto wand CLEAN" is "ON" and you do not use the washing functions (e.g., Rear washing and Front washing) for about 8 hours, you will hear that the wand is cleaned with "EWATER+" and then the remaining water is drained from inside the product. → You can turn it "OFF". 	26
The timer energy saver LED is flashing	<ul style="list-style-type: none"> ● Did you unplug the power plug or was there a power outage? <ul style="list-style-type: none"> • The setting is cancelled. → Set them again (When the power is turned off once, the "Timer energy saver" LED flashes to notify you.) 	23
You feel air in the bowl unit when sitting on the toilet seat*1	<ul style="list-style-type: none"> ● A mist is sprayed inside the bowl unit to make it more difficult for dirt to adhere when sitting on the toilet seat. You may feel air when a mist is sprayed. → You can turn it "OFF". 	- 26

Specifications

Item		SW3074T40 SW3074 SW3073	SW3024 SW3023	
Rated power supply		AC 120 V, 60 Hz		
Type of water heater		Tank type		
Power cord length		3.9 ft (1.2 m)		
Water protection level		IPX4		
Washing	Spray volume ^{*1}	Rear washing	Approx. 0.07-0.11 gal / min (Approx. 0.27-0.43 L / min)	
		Rear soft washing	Approx. 0.07-0.11 gal / min (Approx. 0.27-0.43 L / min) -	
		Front washing	Approx. 0.08-0.11 gal / min (Approx. 0.29-0.43 L / min)	
	Water temperature		Adjustable temperature range : OFF, about 95-104 °F (about 35-40 °C)	
	Toilet tank capacity		Approx. 0.13 gal (Approx. 0.49 L)	
	Heater capacity		225 W	
	Safety device		Temperature fuse, anti-idling float switch	
Backflow prevention device		Vacuum breaker, Check valve		
Heated seat	Surface temperature		Adjustable temperature range : OFF, about 82-97 °F (about 28-36 °C) (Auto energy saver : about 79 °F (about 26 °C))	
	Safety device		Temperature fuse	
Deodorizer	Method		O ₂ deodorization -	
	Airflow volume		Normal mode : Approx. 3.18 ft ³ / min (Approx. 0.09 m ³ / min) Power mode : Approx. 5.65 ft ³ / min (Approx. 0.16 m ³ / min) -	
	Power consumption		Normal mode : Approx. 1.7 W, Power mode : Approx. 5.3 W -	
Warm air dryer	Warm air temperature ^{*2}		Adjustable temperature range : about 95-140 °F (about 35-60 °C)	
	Airflow volume		Approx. 8.83 ft ³ / min (Approx. 0.25 m ³ / min)	
	Heater capacity		347 W	
	Safety device		Temperature fuse	
Water supply pressure		Minimum required water pressure : 7.25 PSI (0.05 MPa) <dynamic> Maximum water pressure : 108.78 PSI (0.75 MPa) <static>		
Water supply temperature		32-95 °F (0-35 °C)		
Working ambient temperature		32-104 °F (0-40 °C)		
Weight		About 11 lb (About 5 kg)		

Item		SW3074T40 SW3074 SW3024	SW3073 SW3023
Rated power consumption		403 W	409 W
Maximum power consumption ^{*3}		512 W	520 W
Heated seat	Heater capacity	48 W	54 W
Dimensions		W 1.55 ft × D 1.74 ft × H 0.48 ft (W 472 mm × D 530 mm × H 147 mm)	W 1.55 ft × D 1.58 ft × H 0.48 ft (W 472 mm × D 483 mm × H 147 mm)

*1 At 29 PSI (0.20 MPa) <dynamic> water pressure.

*2 Temperature around the warm air outlet measured by TOTO.

*3 Maximum power consumption for warm water or heated toilet seat.

●When disposing of this product, please follow your local or state guidelines for proper disposal.

Limited Warranty

One Year Limited Warranty

1. TOTO warrants its products to be free from defects in materials and workmanship during normal use when properly installed and serviced, for a period of one (1) year from date of purchase. This limited warranty is extended only to the ORIGINAL PURCHASER of the product and is not transferable to any third party, including but not limited to any subsequent purchaser or owner of the product. This warranty applies only to TOTO product is purchased and installed in USA and Canada.
2. TOTO's obligations under this warranty are limited to repair, replacement or other appropriate adjustment, at TOTO's option, of the product or parts found to be defective in normal use, provided that such product was properly installed, used and serviced in accordance with instructions.
TOTO reserves the right to make such inspections as may be necessary in order to determine the cause of the defect. TOTO will not charge for labor or parts in connection with warranty repairs or replacements. TOTO is not responsible for the cost of removal, return and/or reinstallation of the product.
3. This warranty does not apply to the following items:
 - a) Damage or loss sustained in a natural calamity such as fire, earthquake, flood, thunder, electrical storm, etc.
 - b) Damage or loss resulting from any accident, unreasonable use, misuse, abuse, negligence, improper care, or maintenance of the product.
 - c) Damage or loss resulting from sediments or foreign matter contained in a water system.
 - d) Damage or loss resulting from the quality of water in the region where the product is used.
 - e) Damage or loss resulting from improper installation or from installation of the product in a harsh and/or hazardous environment, or improper removal, repair or modification of the product. This includes locations where the water pressure is above local codes or standards. (NOTE : Product model codes allow a maximum of 80 PSI. Check local codes or standards for requirements).
 - f) Damage or loss resulting from electrical surges or lightning strikes or other acts which are not the fault of TOTO or which the product is not specified to tolerate, including failure to use the factory equipped cord and plug or use of a loose or faulty electrical outlet or use of a current or socket other than a 120V, 60Hz electrical current from a GFI (ground, fused) socket.
 - g) Damage or loss resulting from normal and customary wear and tear, such as gloss reduction, scratching or fading over time due to use, cleaning practices or water or atmospheric conditions, including but not limited to, the use of bleach, alkali, acid cleaners, dry (powder) cleaners or any other abrasive cleaners or the use of metal or nylon scrubbers.
4. If the Danger Label which has been placed over the seams on the back of the product's top unit is broken or otherwise not intact, this limited warranty is void.
5. In order for this limited warranty to be valid, proof of purchase is required. TOTO encourages warranty registration upon purchase to create a record of product ownership at <http://www.totousa.com>. Product registration is completely voluntary and failure to register will not diminish your limited warranty rights.
6. If the product is used commercially or is installed outside of USA and Canada, TOTO warrants the product to be free from defects in materials and workmanship during normal use for one (1) year from the date of installation of the product, and all other terms of this warranty shall be applicable except the duration of the warranty.
7. This warranty gives you specific legal rights. You may have other rights which vary from state to state, province to province or country to country.
8. To obtain warranty repair service under this warranty, you must take the product or deliver it prepaid to a TOTO service facility together with proof of purchase (original sales receipt) and a letter stating the problem, or contact a TOTO distributor or products service contractor, or write directly to TOTO U.S.A., INC., 1155 Southern Road, Morrow, GA 30260 (888) 295-8134 or (678) 466-1300, if outside the U.S.A. If, because of the size of the product or nature of the defect, the product cannot be returned to TOTO, receipt by TOTO of written notice of the defect together with proof of purchase (original sales receipt) shall constitute delivery. In such case, TOTO may choose to repair the product at the purchaser's location or pay to transport the product to a service facility.

WARNING! TOTO shall not be responsible or liable for any failure of, or damage to, this product caused by either chloramines in the treatment of public water supply or cleaners containing chlorine (calcium hypochlorite).

NOTE: The use of a high concentrate chlorine or chlorine related products can seriously damage the fittings. This damage can cause leakage and serious property damage.

THIS WRITTEN WARRANTY IS THE ONLY WARRANTY MADE BY TOTO. REPAIR, REPLACEMENT OR OTHER APPROPRIATE ADJUSTMENT AS PROVIDED UNDER THIS WARRANTY SHALL BE THE EXCLUSIVE REMEDY AVAILABLE TO THE ORIGINAL PURCHASER. TOTO SHALL NOT BE RESPONSIBLE FOR LOSS OF THE PRODUCT OR FOR OTHER INCIDENTAL, SPECIAL OR CONSEQUENTIAL DAMAGES OR EXPENSES INCURRED BY THE ORIGINAL PURCHASER, OR FOR LABOR OR OTHER COSTS DUE TO INSTALLATION OR REMOVAL, OR COSTS OF REPAIRS BY OTHERS, OR FOR ANY OTHER EXPENSE NOT SPECIFICALLY STATED ABOVE. IN NO EVENT WILL TOTO'S RESPONSIBILITY EXCEED THE PURCHASE PRICE OF THE PRODUCT. EXCEPT TO THE EXTENT PROHIBITED BY APPLICABLE LAW, ANY IMPLIED WARRANTIES, INCLUDING THAT OF MERCHANTABILITY OR FITNESS FOR USE OR FOR A PARTICULAR PURPOSE, ARE EXPRESSLY DISCLAIMED. SOME STATES DO NOT ALLOW LIMITATIONS ON HOW LONG AN IMPLIED WARRANTY LASTS, OR THE EXCLUSION OR LIMITATION OF INCIDENTAL OR CONSEQUENTIAL DAMAGES, SO THE ABOVE LIMITATION AND EXCLUSION MAY NOT APPLY TO YOU.